

Product data sheet

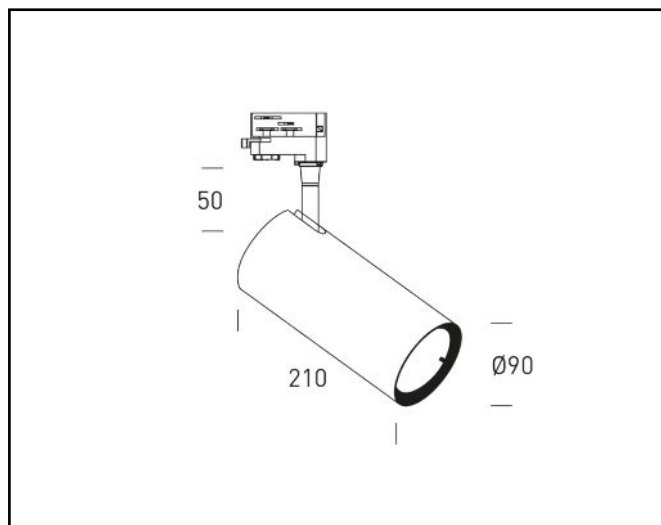

BERLIN 30

21W-30W – 1730lm-2625lm – 2700K-4000K 45°



Description	Track spot
Dimensions (mm)	80mmx185mmx50mm
Weight (kg)	850g
Housing	PA body
Colour	White or Black
Optical system	Aluminium reflector
Lighting Distribution	45°
Unified Glare Ratio	<22
Colour temperature (K)	2700K – 4000K
CRI (Ra)	80
SCDM	3
Net lumen output (25°C)	1730lm – 2625lm
Efficacy – LOR (lm/W)	82lm/W
Power (driver incl.)	21W – 30W
Driver	Integrated
IP	IP 20
IK	IK 02
Lifetime (hours)	35.000 hours L70 B50
Warranty	3 years
Origin	Spain
Norms	LVD 2006/95/EC EMC 2004/108/EC RoHS 2001/65/EC ISO 9001:2008
Marks	

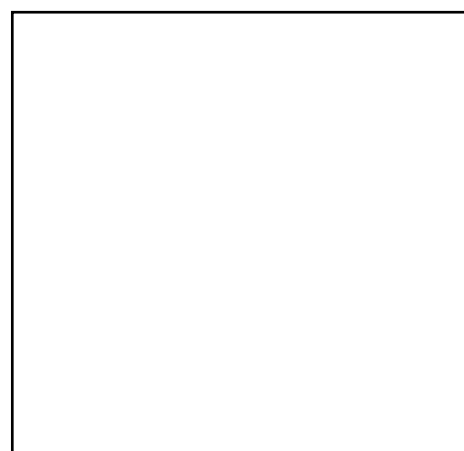

All specifications, descriptions and images are purely informative, not binding and subject to errors and changes

Euro-Luce Light Engineering
Ballingsweg 25 – 9620 Zottegem
info@euro-luce.be
www.euro-luce.be
Tel 0032 54 55 71 10